

Spherical roller bearings, cylindrical and tapered bore

Principal dimensions			Basic load ratings		Speed ratings		Designation
d	D	B	dynamic C	static C0	Reference speed	Limiting speed	
mm			kN		r/min		
280	460	180	3183	5100	630	900	* SKF Explorer bearing 24156 CCK30/W33 *

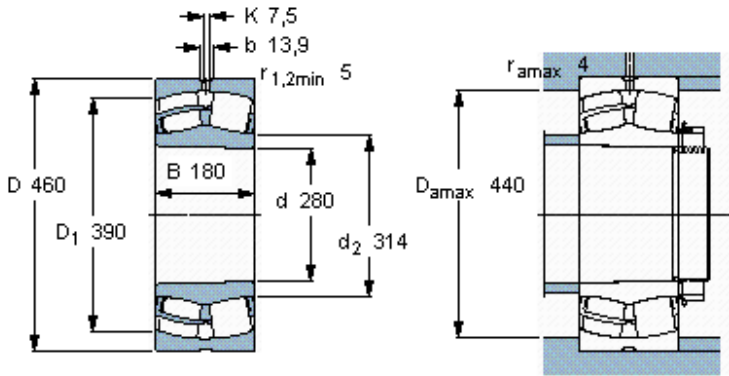

Tapered bore, taper
1: 30

Calculation factors

- e 0,4
- Y₁ 1,7
- Y₂ 2,5
- Y₀ 1,6